

KOMATSU®

PC450-8 PC450LC-8

PC
450

HORSEPOWER

Gross: 270 kW 362 HP / 1900 min⁻¹

Net: 257 kW 345 HP / 1900 min⁻¹

OPERATING WEIGHT

PC450-8: 43320 – 43740 kg

PC450LC-8: 44320 – 44770 kg

BUCKET CAPACITY

1.30 – 2.80 m³



Photos may include optional equipment.

WALK-AROUND



Heavy-duty Boom

Heavy-duty Arm

Quarry Bucket



Quarry Cab

Strengthened Revolving Frame with Deck Guard

Full Roller Guards and Double-flange Track Rollers

PRODUCTIVITY, ECOLOGY & ECONOMY

- Low Fuel Consumption by Total Control of the Engine, Hydraulic and Electronic System
- Low Emission Engine and Low Operation Noise
- Excellent Machine Stability
- Large Digging Force
- Two-mode Setting for Boom
- Variable Track Gauge (Optional)

COMFORT & SAFETY

- Large Comfortable Cab
- ROPS Cab (ISO 12117-2)
- Automatic Air Conditioner (A/C) (Optional)
- Rear View Monitor System (Optional)

* Information and Communication Technology

ICT* & KOMTRAX

- Large Multi-lingual Liquid Crystal Display (LCD) Monitor
- Equipment Management Monitoring System
- KOMTRAX

MAINTENANCE & RELIABILITY

- Easy Maintenance
- Excellent Reliability and Durability



	PC450-8	PC450LC-8
HORSEPOWER	Gross: 270 kW 362 HP / 1900 min ⁻¹ Net: 257 kW 345 HP / 1900 min ⁻¹	270 kW 362 HP / 1900 min ⁻¹ 257 kW 345 HP / 1900 min ⁻¹
OPERATING WEIGHT	43320 – 43740 kg	44320 – 44770 kg
BUCKET CAPACITY	1.30 – 2.80 m ³	1.30 – 2.80 m ³

PRODUCTIVITY, ECOLOGY & ECONOMY

Komatsu Technology

Komatsu develops and produces all major components, such as engines, electronics and hydraulic components, in house. With this “Komatsu Technology” and adding customer feedback, Komatsu is achieving great advancements in technology. To achieve both high levels of productivity and economical performance, Komatsu has developed the main components with a total control system. The result is a new generation of high performance and environment friendly excavators.

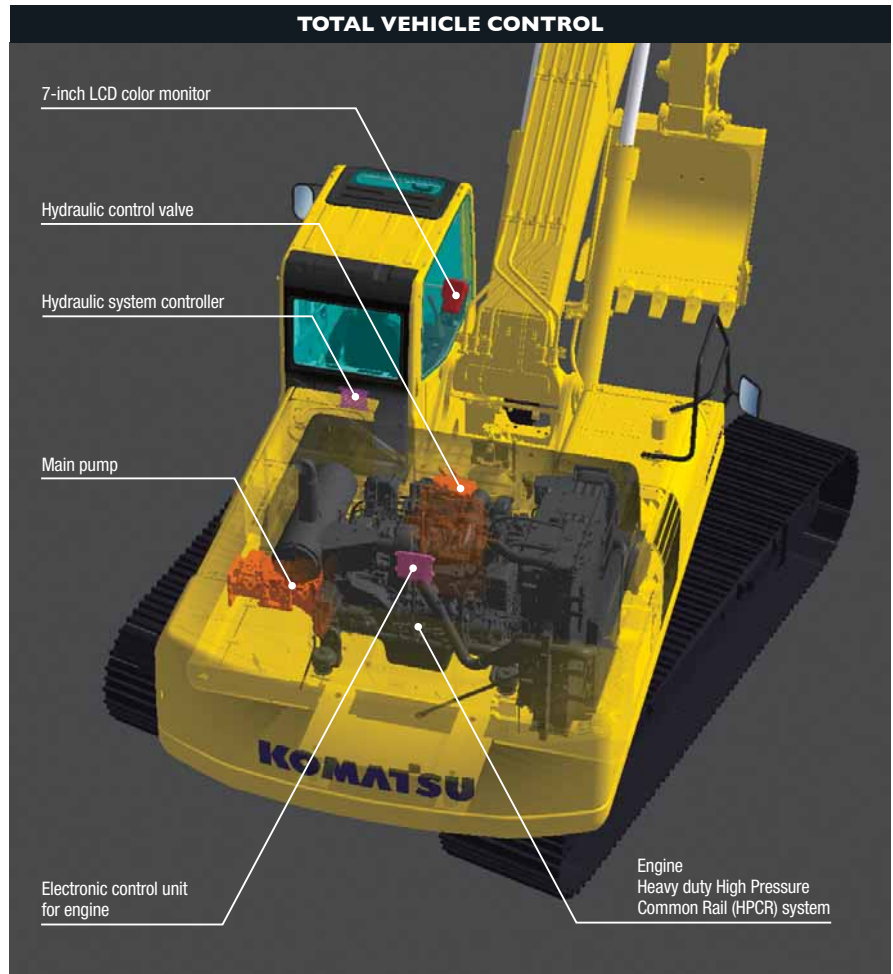

Environment-friendly Clean Engine

The PC450-8 gets its exceptional power and work capacity from a Komatsu SAA6D125E-5 engine. Output is 257 kW 345 HP, providing increased hydraulic power and improved fuel efficiency. Komatsu SAA6D125E-5 engine is U.S. EPA Tier 3 and EU Stage 3A emissions certified with NOx emission reduced by 40%. The SAA6D125E-5 engine adopts the electronically controlled heavy duty High Pressure Common Rail (HPCR) fuel injection system and cooled Exhaust Gas Recirculation (EGR) system with electronically controlled bypass-assist type venturi.



Low Operation Noise

Enables a low noise operation using the low-noise engine and methods to cut noise at source. Ambient noise meets the EU Stage 2 noise regulation.

Excellent Machine Stability

Large counterweight offers superior machine stability and balance.

Idling Caution

To prevent unnecessary fuel consumption, an idling caution is displayed on the monitor, if the engine idles for 5 minutes or more.



ECO Gauge that Assists Energy-saving Operations

Equipped with the ECO gauge that can be recognized at a glance on the right of the multi-function color monitor for environment-friendly energy-saving operations. Allows focus on operation in the green range with reduced CO₂ emissions and efficient fuel consumption.



ECO gauge

Working Modes Selectable

The PC450-8 excavator is equipped with five working modes (P, E, L, B and ATT mode). Each mode is designed to match engine speed and pump output to the application. This provides the flexibility to match equipment performance to the job at hand.



Working Mode	Application	Advantage
P	Power mode	<ul style="list-style-type: none"> • Maximum production/power • Fast cycle times
E	Economy mode	<ul style="list-style-type: none"> • Good cycle times • Better fuel economy
L	Lifting mode	<ul style="list-style-type: none"> • Suitable attachment speed • Lifting capacity is increased 7% by raising hydraulic pressure.
B	Breaker mode	<ul style="list-style-type: none"> • Optimum engine rpm, hydraulic flow
ATT	Attachment mode	<ul style="list-style-type: none"> • Optimum engine rpm, hydraulic flow, 2 way

Variable Track Gauge (Optional)

- Lateral stability is significantly improved when operating with the gauge extended.
- Lateral stability is increased by 30% (Compared with the fixed gauge version).
- With trackframes retracted, overall width complies with many local transportation regulations.



Large Digging Force

When press the left knob switch which is called the one-touch power max. switch and when it is kept pressed, this function temporarily increases digging force for 8.5 seconds of operation.

Maximum arm crowd force (ISO 6015):
 218 kN (22.2 t) ➔ **233 kN (23.8 t)** **7% UP**
 (With Power Max.)

Maximum bucket digging force (ISO 6015):
 259 kN (26.4 t) ➔ **278 kN (28.3 t)** **7% UP**
 (With Power Max.)

Measured with Power Max. function, 3380 mm arm and ISO 6015 rating.

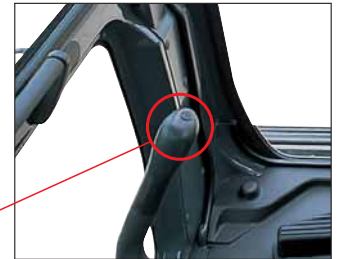

One-touch power max. switch

Smooth Loading Operation

Two return hoses improve hydraulic performance. In the arm out function, a portion of the oil is returned directly to the tank providing smooth operation.

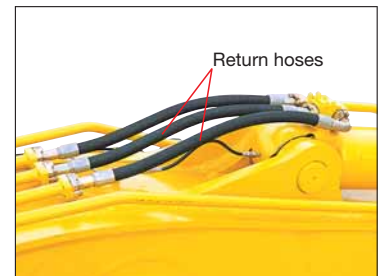

Return hoses

Two-mode Setting for Boom

Smooth mode provides easy operation for gathering blasted rock or scraping down operation. When maximum digging force is needed, switch to Power mode for more effective excavating.

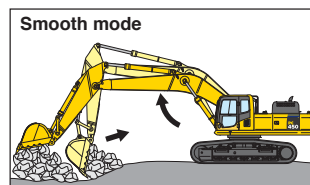

Boom floats upward, reducing lifting of machine front. This facilitates gathering blasted rock and scraping down operations.

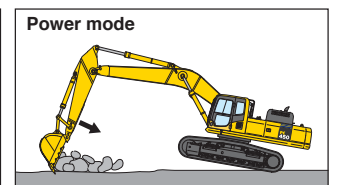

Boom pushing force is increased, ditch digging and box digging operation on hard ground are improved.

COMFORT



Low Cab Noise

The newly-designed cab is highly rigid and has excellent sound absorption ability. Thorough improvement of noise source reduction and use of low noise engine, hydraulic equipment, and air conditioner allows this machine to generate a low level of noise.

Low Vibration with Cab Damper Mounting

PC450-8 uses viscous damper mounting for cab that incorporates longer stroke and the addition of a spring. The new cab damper mounting combined with high rigidity deck aids vibration reduction at operator seat.

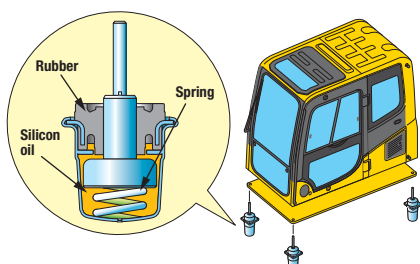

Wide Newly-designed Cab

Newly-designed wide spacious cab includes seat with reclining backrest. The seat height and longitudinal inclination are easily adjusted using a pull-up lever. You can set the appropriate operational posture of armrest together with the console. Reclining the seat further enables you to place it into the fully flat state with the headrest attached.



Pressurized Cab

Optional air conditioner (A/C), air filter and a higher internal air pressure minimize external dust from entering the cab.

Automatic Air Conditioner (A/C) (Optional)

Enables you to easily and precisely set cab atmosphere with the instruments on the large LCD. The bi-level control function keeps the operator's head and feet cool and warm respectively. This improved air flow function keeps the inside of the cab comfortable throughout the year. Defroster function keeps front glass clear.

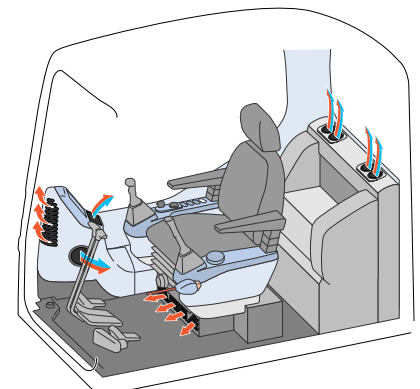

SAFETY

ROPS Cab

The machine is equipped with a ROPS cab that conforms to ISO 12117-2 for excavators as standard equipment. The ROPS cab has high shock-absorption performance, featuring excellent durability and impact strength. It also satisfies the requirements of OPG top guard level 1 (ISO 10262) for falling objects. Combined with the retractable seat belt, The ROPS cab protects the operator in case of tipping over and against falling objects.

ROPS CAB STRUCTURE

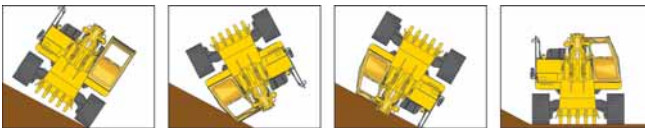
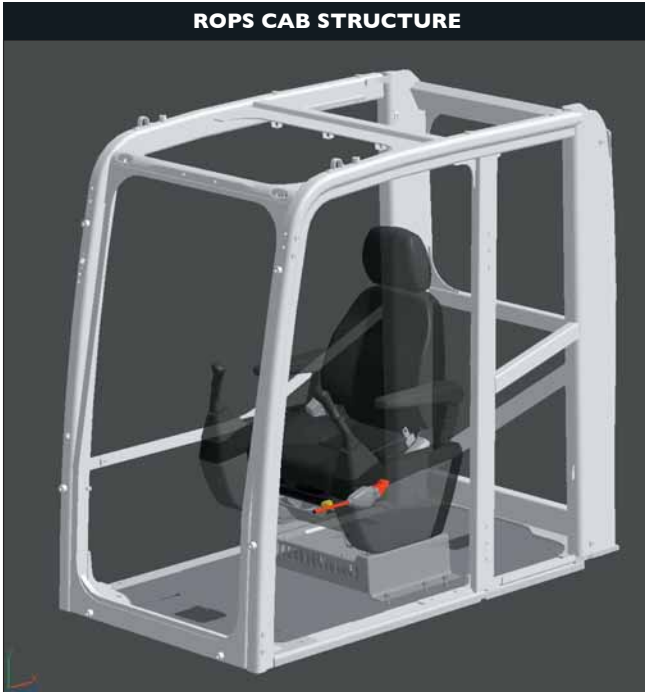

Slip-resistant Plates

Highly durable slip-resistant plates maintain superior traction performance for the long term.



Lock Lever

Locks the hydraulic pressure to prevent unintentional movement. Neutral start function allows machine to be started only in lock position.



Rear View Monitor System (Optional)

The operator can view the rear of the machine with a color monitor screen.



Rear view image on monitor

Pump/Engine Room Partition

Pump/engine room partition prevents oil from spraying onto the engine if a hydraulic hose should fail.



Thermal and Fan Guards

Thermal and fan guards are placed around high-temperature parts of the engine and fan drive.



Large Serrated Steps and Handrail

Large serrated steps



Large handrail



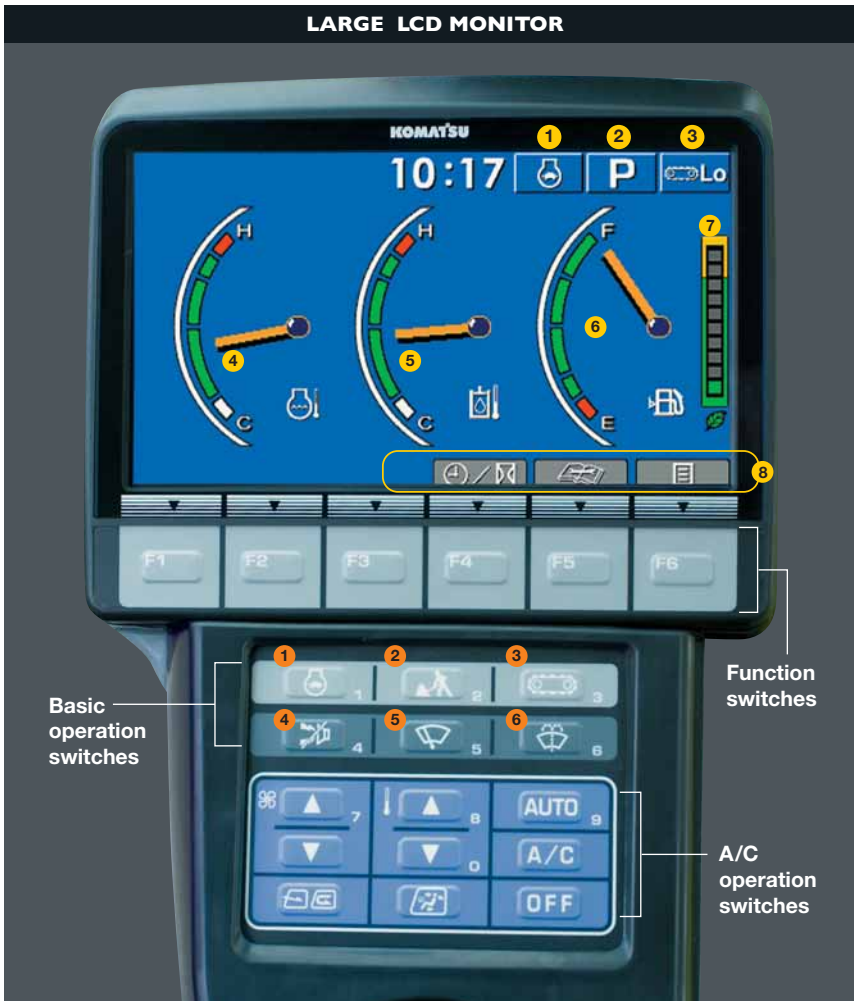

Large Multi-lingual LCD Monitor

A large user-friendly color monitor enables safe, accurate and smooth work. Improved screen visibility is achieved by the use of LCD that can easily be read at various angles and lighting conditions. Simple and easy to operate switches. Function keys facilitate multi-function operations. Displays data in 12 languages to globally support operators around the world.

Indicators

- | | |
|----------------------------------|-----------------------------------|
| 1 Auto-decelerator | 5 Hydraulic oil temperature gauge |
| 2 Working mode | 6 Fuel gauge |
| 3 Travel speed | 7 ECO gauge |
| 4 Engine water temperature gauge | 8 Function switches menu |

Basic operation switches

- | | |
|-------------------------|---------------------|
| 1 Auto-decelerator | 4 Buzzer cancel |
| 2 Working mode selector | 5 Wiper |
| 3 Traveling selector | 6 Windshield washer |

Equipment Management Monitoring System

Monitor function

Controller monitors engine oil level, coolant temperature, battery charge and air clogging, etc. If controller finds any abnormality, it is displayed on the LCD.



Maintenance function

Monitor informs replacement time of oil and filters on the LCD when the replacement interval is reached.



Trouble data memory function

Monitor stores abnormalities for effective troubleshooting.



Assists Customer's Equipment Management and Contributes to Fuel Cost Cutting

Equipment Management Support

KOMTRAX terminal installed on your machine collects and sends information such as machine location, working record, machine conditions, etc. using wireless communication. You can review the KOMTRAX data remotely via the online application. KOMTRAX not only gives you the informations on your machine, but also the convenience of managing your fleet on the Web.

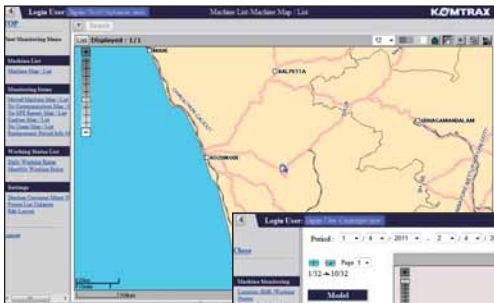

Location

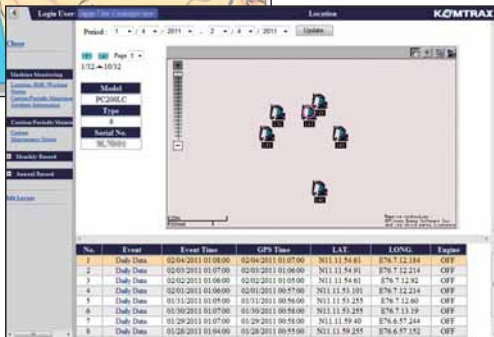

Movement generated position



Operation map



Monthly status summary

Energy-saving Operation Support Report

KOMTRAX can provide various useful information which includes the energy-saving operation support report created based on the operating information of your machine such as fuel consumption and idle time.

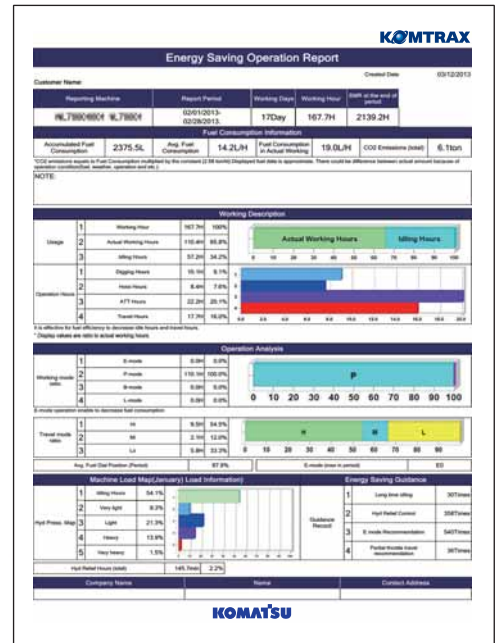

Image

MAINTENANCE

Easy Access to Engine Oil Filter and Fuel Drain Valve

Engine oil dipstick and fill, and fuel filter are mounted on same side to improve accessibility. Fuel drain valve are remotely mounted to improve accessibility.



Fuel drain valve

Easy Radiator Cleaning

Since radiator and oil cooler are arranged side-by-side, it is easy to clean, remove and install them.

Large-size Steps

On both right and left track frames are fixed with wider steps for easier maintenance.



Large Capacity Air Cleaner

Large capacity air cleaner is comparable to that of larger machines. The larger air cleaner can extend air cleaner life during long-term operation and prevents early clogging and resulting power decrease. Reliability is improved by a new seal design.



Long-life Oil, Filter

Uses high-performance filtering materials and long-life oil. Extends the oil and filter replacement interval.



Hydraulic oil filter

Engine oil & Engine oil filter	every 500 hours
Hydraulic oil	every 5000 hours
Hydraulic oil filter	every 1000 hours

Long Work Equipment Greasing Interval (Optional)

High quality bushings and resin shims are optionally available for work equipment pins excluding bucket, extending greasing interval to 500 hours.

Large Fuel Tank Capacity

Large fuel tank capacity extends operating hours before refueling. Fuel tank is treated for rust prevention and improved corrosion resistance.



RELIABILITY

High Pressure In-line Filter

In-line filters are provided at outlet port (Pressure side) of each pump to protect hydraulic system contamination.



In-line filters

Equipped with Fuel Pre-filter (With Water Separator)

Removes water and contaminants in the fuel to prevent fuel problems.



Metal Guard Rings

Metal guard rings protect all the hydraulic cylinders and improve reliability.

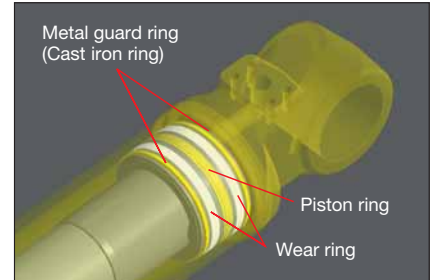

Fuel Main-filter

The reliability of fuel systems is improved, because fuel main-filter removes contamination and sludge contained in fuel.



O-ring Face Seal

The hydraulic hose seal method has been changed from a conventional taper seal to an O-ring seal. This provides improved sealing performance.



Shield Connectors

Shield connectors seal tight and have higher reliability.

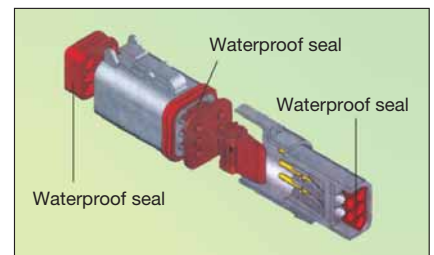

OPTIONS

- Cab front full height guard level 1 (ISO 10262)



- Cab front full height guard level 2 (ISO 10262)



- Additional front lights
- Rain visor



- Air pre-cleaner



- OPG top guard level 2 (ISO 10262)



- Strengthened track frame undercover



- Sun visor



- Seat, suspension



KOMATSU BRAND BUCKET

KOMATSU Brand Bucket for General Purpose with Wide Bucket Width

Me Bucket

- Low resistant excavation
- High productivity
- High durability
- High fuel efficiency

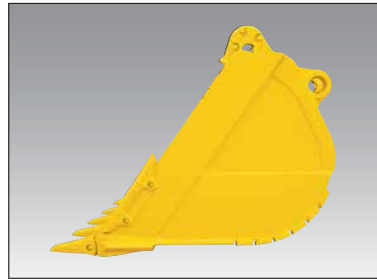



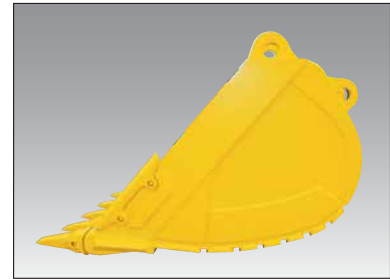



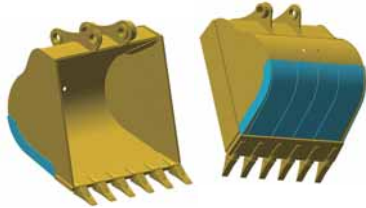

Conventional

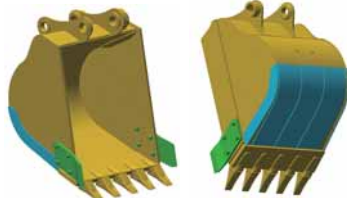

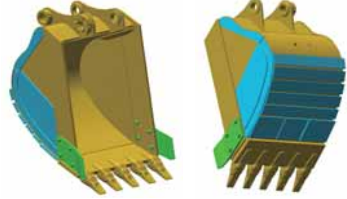
Me Bucket

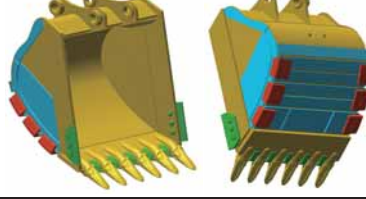
Category and Feature

Category	Load / Wear / Soil (Application)	Image
Light Duty LD	<p>Load Machine power remains low during the majority of the work. No impact load.</p> <p>Wear Material is not abrasive.</p> <p>Soil Dirt, loam and clay.</p>	 
General Purpose GP	<p>Load Machine power is mostly medium, but occasionally high. Bucket movements are smooth with minor shock load. Bucket penetrates easily.</p> <p>Wear Material is lightly abrasive. Some sand may be medium abrasive.</p> <p>Soil Mostly loose sand, gravel and finely broken materials.</p>	 
Heavy Duty HD	<p>Load Machine power is high during majority of the work. Medium, but continuous shock load.</p> <p>Wear Material is abrasive. Light scratch marks can be seen at the bucket.</p> <p>Soil Limestone, shot rock, compact mix of sand, gravel and clay.</p>	 
Extra Heavy Duty XHD	<p>Load Machine power is high during most of the work, often at maximum. Dynamic shock loads are frequent and machine may shake.</p> <p>Wear Material is very abrasive. Large scratch marks are visible and, or deform metal. Works within heaps of rock with occasional un-shot rock and rock boulders.</p> <p>Soil Granite, basalt, quartz sand, compact and sticky clay.</p>	 

Bucket Line-up

Category	Bucket Type	Capacity (m³)	Width*1 (mm)	Weight*2 (kg)	Tooth Quantity	Boom + Arm (m)		Tooth Type			
						7.06+3.38	6.67+2.40 SE Spec.	Vertical	Horizontal	PAB*3	KMAX
LD	Conventional	2.20	— <1715>	1395	5	●	—	✓	✓	✓	✓
		1.30	1270<1120>	1115	4	○	—	✓			
GP	Conventional	1.60	1420<1270>	1197	5	○	—		✓	✓	
		1.90	1625<1475>	1358	5	○	—		✓	✓	
		2.06	1715<1565>	1391	5	□	—		✓	✓	✓
		1.90	1625<1475>	1965	5	○	—		✓	✓	✓
HD	Me Bucket	1.90	1625<1475>	2025	5	○	—		✓	✓	✓
		2.10	1625<1475>	1610	5	○	—		✓	✓	✓
		2.80	1700<1525>	3080	5	×	□		✓	✓	✓
XHD	Me Bucket	1.90	— <1715>	2069	5	○	—		✓	✓	
		2.10	1270<1120>	2165	5	□	—		✓	✓	
		2.80	1700<1525>	3285	5	×	□		✓	✓	✓

*1 With side cutters or side shrouds, < > without side cutters or side shrouds *2 With side cutters *3 PAB: Pin And Bushing system ☆: Heavy duty work, density up to 2.1 t/m³
 ○: General purpose use, density up to 1.8 t/m³ □: General purpose use, density up to 1.5 t/m³ ●: Light duty work, density up to 1.2 t/m³ ×: Not usable ✓: Selectable

Feature of [Me Bucket] (More suitable shape and Effectiveness Bucket)

High Productivity by Low-resistant Excavation

The new Ideal bucket profile produces lower resistance at inside & outside bucket and production will be greatly increased.

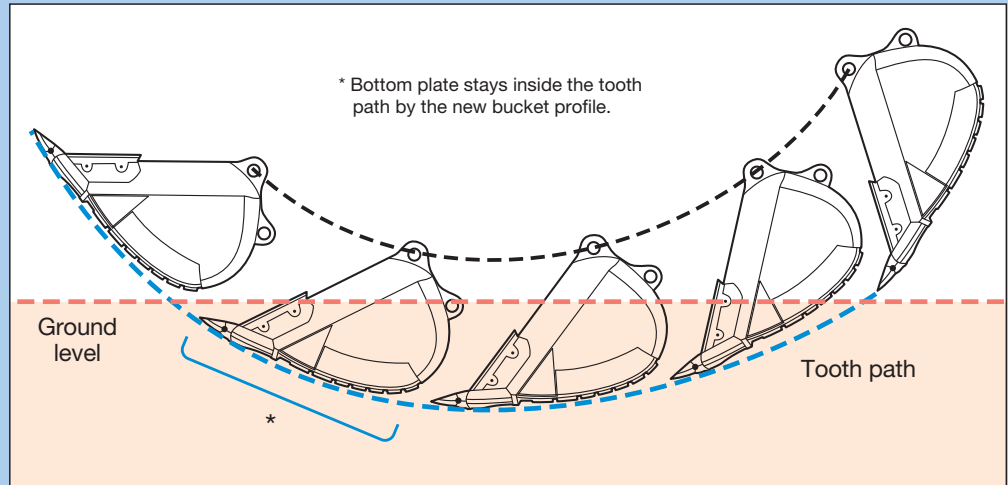

Feature of [PAB Tooth] (Pin And Bushing system Tooth)

- Able to fit on the bucket with horizontal pin type adapter
 - Easy change-out only with a ratchet wrench
 - Longer tooth life by easy rotation and turnover
 - Durable and reusable PAB pin with flat surface
- Limited to where horizontal pin type tooth is mainly used.

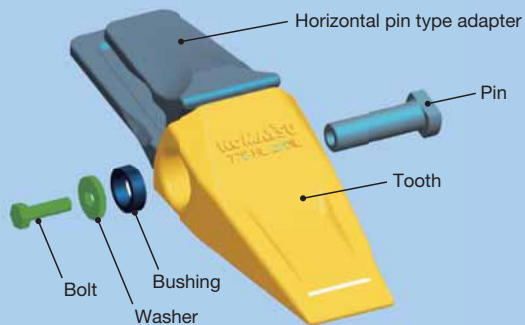

Set PAB tooth to horizontal pin type adapter



Insert exclusive pin to the adapter pin hole



Set bushing, washer and bolt and tighten by a ratchet wrench

■ PAB Tooth Line-up

Type	Style
Integrated Long Life IL	
Heavy Standard HS	
Heavy Rock HR	
Self Sharp SYL	
Hybrid HB	

■ Applicable Working Site

Application	Soil	Tight Material ←————→ Loose Material			
		Soiled Rock	Broken Rock	Clay	Gravel Sand
Extreme Heavy Excavation	HB Hybrid				
Heavy Excavation	HR Heavy rock		HS Heavy standard		
General Application				SYL Self sharp	
Loading/Unloading					IL Integrated long life

Special Purpose Bucket & Ripper

■ Feature and Specifications



Type	Feature	Bucket Capacity (SAE J 296 Heaped)	Width	Image
Ripper Bucket	Suitable for digging rock bed or hard clayey soil when normal buckets cannot penetrate deep enough. Loading is also possible.	1.10 m ³	1250 mm	
Single-shank Ripper	This ripper is used for site preparation prior to digging work, when it becomes necessary to remove rocks, pavement for other obstacles. Also effective for pulling out tree stumps.	—	—	



Photo may include optional equipment.

HENSLEY BRAND BUCKET

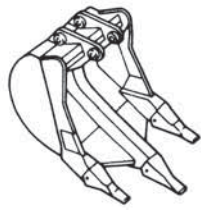
Diverse Bucket Capacity by Application Featuring "KMAX" Tooth System



- Wide range selection for each application
- Larger profile and capacity to maximize production
- Multiple width options to meet specific job requirements and reduce backfill

Category and Recommended Applications

Category	Recommended Applications	Image
Trenching and Loading TL	Dirt, loam, sand, gravel, loose clay, abrasive soils with limited rock mixture.	
Heavy Duty Plate Lip Bucket with Wear Plate HP	Abrasive soils, compact or dense clay, loose rock and gravel.	
Heavy Duty Plate Lip Bucket with Wear Plate & Wear Strips HPS	Abrasive soils, compact or dense clay, loose rock and gravel.	
Extreme Duty Plate Lip Bucket with Special Features HPX	Shot rock, stratified materials, quarry or tough, highly abrasive applications.	

Bucket Line-up

Category	Capacity (m³)	Width (mm)	Weight (kg)	Tooth Quantity	Boom + Arm (m)		Tooth Type
					7.06+3.38	6.67+2.40 SEspec.	
TL	1.12	762	1291	3	☆	☆	✓
	1.35	914	1444	4	☆	☆	✓
	1.64	1067	1565	4	☆	☆	✓
	1.94	1219	1724	5	○	☆	✓
	2.25	1372	1912	6	□	☆	✓
	2.55	1524	2012	6	●	○	✓
	2.87	1676	2171	7	■	□	✓
HP	3.17	1829	2296	7	×	□	✓
	1.12	762	1488	3	☆	☆	✓
	1.35	914	1677	4	☆	☆	✓
	1.64	1067	1818	4	☆	☆	✓
	1.94	1219	1994	5	○	☆	✓
	2.25	1372	2170	6	□	☆	✓
	2.55	1524	2540	6	●	○	✓
HPS	2.87	1676	2764	7	■	□	✓
	3.17	1829	2898	7	×	●	✓
	1.12	762	1583	3	☆	☆	✓
	1.35	914	1790	4	☆	☆	✓
	1.64	1067	1952	4	☆	☆	✓
	1.94	1219	2143	5	□	☆	✓
	2.25	1372	2342	6	●	☆	✓
HPX	2.55	1524	2729	6	■	□	✓
	2.87	1676	2973	7	■	●	✓
	3.17	1829	3126	7	×	●	✓
	1.12	762	1774	3	☆	☆	✓
	1.35	914	2019	4	☆	☆	✓
	1.64	1067	2192	4	○	☆	✓
	1.94	1219	2412	5	□	☆	✓
HPX	2.25	1372	2643	6	●	○	✓
	2.55	1524	2903	6	■	□	✓
	2.87	1676	2989	7	×	●	✓
	3.17	1829	3334	7	×	●	✓

☆: Heavy duty work, density up to 2.1 t/m³ ○: General purpose use, density up to 1.8 t/m³
 □: General purpose use, density up to 1.5 t/m³ ●: Light duty work, density up to 1.2 t/m³
 ■: Light duty work, density up to 0.9 t/m³ ×: Not usable ✓: Selectable

Feature of KMAX Tooth System

- Better penetration and cycle times
- Hardness throughout the tooth
- Unique high strength design
- Unique reusable fastener
- Less "throw away" waste
- Fast tooth changeover



Tooth



477-532 Brinell level of hardness throughout the tooth.

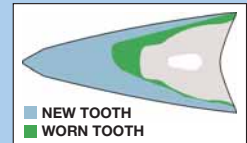

The KMAX RC style tooth shown here offers a consumption ratio of 60%.

Fastener

Simple, reusable fastener system saves time and money by unlocking with a simple 90-degree turn.



To lock, use the correct size socket, rotate the pin locking shaft 90-degree clockwise to finish the installation.



When removing the fastener, use the correct size socket to rotate the pin-locking shaft 90-degree counter-clockwise.

KMAX Tooth Line-up

Feature	Style
F Flare: Loose material for clean bottom and greater fill	
SYL Standard: General applications	
SD Chisel: General purpose tooth Designed for penetration	
RC Rock Chisel: Designed for penetration and long wear life	
T Tiger: Designed for good penetration with ribs for strength	
TV Tiger: Offers best penetration in tight material	
UT Twin Tiger: Offers longer life penetration for corners	
WT Twin Tiger: Designed for penetration for corners	

Some application may not have been available in your country or region. If you are interested in such application, please contact a KOMATSU office near you.

QUARRY HYDRAULIC EXCAVATOR

The PC450-8 is a specially designed for heavy-duty applications. The PC450-8 has strengthened work equipment and reinforced body parts for use in severe job sites such as quarry and gravel gathering, etc.



Photo may include optional equipment.

Quarry bucket

PC450-8 bucket is designed exclusively for quarry use and is higher strength for impact and wear. Various parts of work equipment are also strengthened.

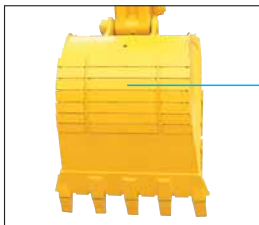
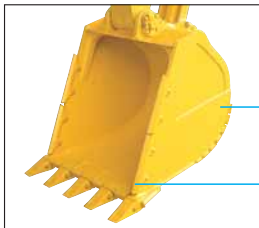

Full roller guard



Strengthened revolving frame underguard



Corner tooth adapters

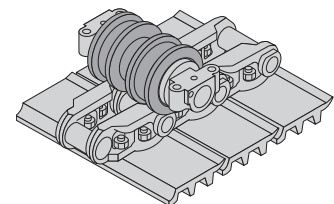
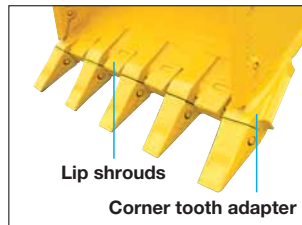

Double-flange track roller

Double-flange rollers guide track link correctly and extends life of undercarriage.

Number of double-flange track rollers

PC450-83 each side
PC450LC-8.....4 each side

SE SPEC.

PC450LC-8 SE spec. is equipped with a large reinforced Me bucket for quarrying work. It increases the efficiency of loading a dump truck with large amounts of loose materials such as blasted rock.

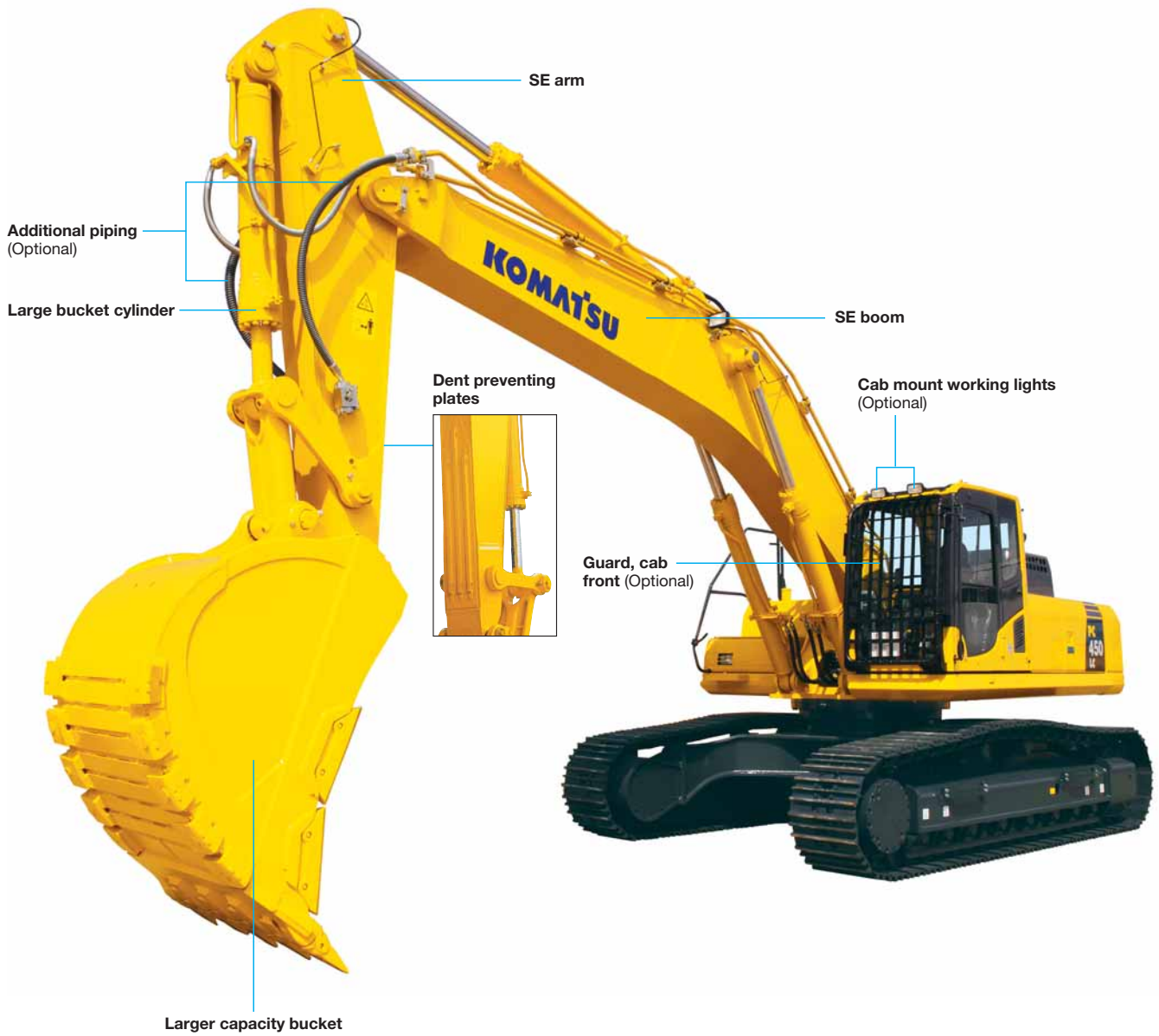

ATTACHMENT

Komatsu Genuine Attachment Tool

Komatsu-recommended attachment tools for hydraulic excavators
A wide range of attachment tools are provided to suit customers' specific applications.

Hydraulic breaker

The hydraulic breaker is an attachment tool used for crushing rock beds and paved surfaces, demolishing concrete structures, etc. The large gas chamber, ideal gas pressure ratio, and long-stroke piston deliver a powerful impact force. Since the breaker unit does not require an accumulator, the number of parts has been reduced, resulting in lower maintenance costs.



Crusher

This attachment tool is used for demolishing concrete structures. Since it does not have a striking mechanism and features low noise and low vibration, it is suitable for work in urban areas. The open-close cylinder is equipped with a speed-up valve for increasing work speed.



Primary crusher



Pulverizer



Scrap & demolition shear

The scrap & demolition shears have multiple applications for both overhead-demolishing the steel structure (General structural steels) and cutting structural steel with required length at ground level. (In foundries, dumps, scrap yards)



Applications of Attachment Tools

Application/ Attachment Tool	Civil Engineering	Quarry	Demolition	Industrial Waste Disposal	Iron-making	Utility Construction	Rental
Hydraulic Breaker	○	○	○	○	○	○	○
Crusher (Primary Crusher)			○				○
Crusher (Pulverizer)			○	○			○
Scrap & Demolition Shear			○	○			○

KOMATSU TOTAL SUPPORT



Komatsu Total Support

To keep your machine available and minimize operation cost when you need it, Komatsu Distributor is ready to provide variety of support before and after procuring the machine.

Fleet recommendation

Komatsu Distributor can study customer job site and provide the most optimum fleet recommendation with detailed information to meet all of your application needs when you are considering to buy new machines or to replace the existing ones from Komatsu.



Product support

Komatsu Distributor secure the certain quality of machine will be delivered.

Parts availability

Komatsu Distributor is available for emergency inquiry by the customers for genuine, quality guaranteed Komatsu parts.

Technical support

Komatsu product support service (Technical support) are designed to help customer. Komatsu Distributor offers a variety of effective services how much Komatsu is dedicated to the maintenance and support of Komatsu machine.

- Preventive Maintenance (PM) clinic
- Oil & Wear analysis program
- Undercarriage inspection service, etc.

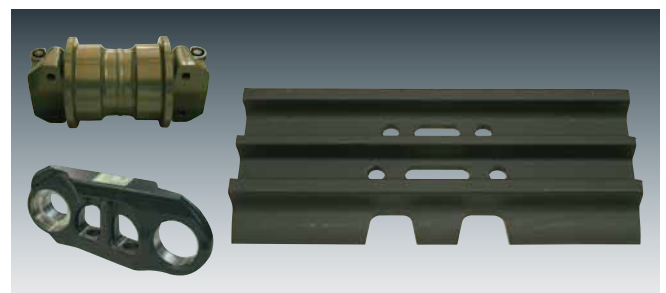

Repair & maintenance service

Komatsu Distributor offers quality repair service, periodical maintenance, and maintenance service to the customer, utilizing and promoting Komatsu developed programs.

Komatsu Reman (Remanufactured) components

Komatsu Reman products are the result of the implementation of the Komatsu global Reman policy which establishes and agrees to reduce the owning, operating and total Life Cycle Costs (LCC) to Komatsu's customer through prompt delivery, high quality and competitively priced in own remanufactured products (QDC).



SPECIFICATIONS



ENGINE

Model Komatsu SAA6D125E-5
 Type Water-cooled, 4-cycle, direct injection
 Aspiration Turbocharged, aftercooled
 Number of cylinders 6
 Bore 125 mm
 Stroke 150 mm
 Piston displacement 11.04 L
 Horsepower:
 SAE J1995 Gross 270 kW 362 HP
 ISO 9249 / SAE J1349 Net 257 kW 345 HP
 Rated rpm 1900 min⁻¹
 Fan drive method for radiator cooling Mechanical
 Governor All-speed control, electronic

U.S. EPA Tier 3 and EU Stage 3A emissions certified.



HYDRAULICS

Type .. HydraMind (Hydraulic Mechanical Intelligence New Design) system, closed-center system with load sensing valves and pressure compensated valves
 Number of selectable working modes 4
 Main pump:
 Type Variable displacement piston type
 Pumps for Boom, arm, bucket, swing, and travel circuits
 Maximum flow 690 L/min
 Supply for control circuit Self-reducing valve
 Hydraulic motors:
 Travel 2 x axial piston motor with parking brake
 Swing 1 x axial piston motor with swing holding brake
 Relief valve setting:
 Implement circuits 37.3 MPa 380 kg/cm²
 Travel circuit 37.3 MPa 380 kg/cm²
 Swing circuit 27.9 MPa 285 kg/cm²
 Pilot circuit 3.2 MPa 33 kg/cm²
 Hydraulic cylinders:
 (Number of cylinders – bore x stroke x rod diameter)
 Boom 2–160 mm x 1570 mm x 110 mm
 Arm
 Std 1–185 mm x 1985 mm x 130 mm
 SE 1–185 mm x 1820 mm x 120 mm
 Bucket
 Std 1–160 mm x 1270 mm x 110 mm
 SE 1–185 mm x 1160 mm x 120 mm



DRIVES AND BRAKES

Steering control Two levers with pedals
 Drive method Hydrostatic
 Maximum drawbar pull 330 kN 33700 kg
 Gradeability 70%, 35°
 Maximum travel speed: High 5.5 km/h
 (Auto-shift) Mid 4.0 km/h
 (Auto-shift) Low 3.0 km/h
 Service brake Hydraulic lock
 Parking brake Mechanical disc brake



SWING SYSTEM

Drive method Hydrostatic
 Swing reduction Planetary gear
 Swing circle lubrication Grease-bathed
 Service brake Hydraulic lock
 Holding brake/swing lock Mechanical disc brake
 Swing speed 9.1 min⁻¹



UNDERCARRIAGE

Center frame X-frame
 Track frame Box-section
 Seal of track Sealed track
 Track adjuster Hydraulic
 Number of shoes (Each side):
 PC450-8 46
 PC450LC-8 49
 Number of carrier rollers (Each side) 2
 Number of track rollers (Each side):
 PC450-8 7
 PC450LC-8 8



COOLANT AND LUBRICANT CAPACITY (REFILLING)

Fuel tank 650 L
 Coolant 36.0 L
 Engine 37.0 L
 Final drive (Each side) 10.5 L
 Swing drive 20.0 L
 Hydraulic tank 248 L



OPERATING WEIGHT (APPROXIMATE)

Operating weight including 7060 mm one-piece boom, 3380 mm arm, ISO 7451 heaped 1.90 m³ backhoe bucket, rated capacity of lubricants, coolant, full fuel tank, operator, and standard equipment.

Shoes	PC450-8		PC450LC-8	
	Operating Weight	Ground Pressure	Operating Weight	Ground Pressure
600 mm	43320 kg	80.7 kPa 0.82 kg/cm ²	44320 kg	76.8 kPa 0.78 kg/cm ²
700 mm	43740 kg	69.9 kPa 0.71 kg/cm ²	44770 kg	66.5 kPa 0.68 kg/cm ²

Operating weight including 6670 mm one-piece boom, 2400 mm arm, ISO 7451 heaped 1.90 m³ backhoe bucket, rated capacity of lubricants, coolant, full fuel tank, operator, and standard equipment.

Shoe	PC450-8 SE Spec.		PC450LC-8 SE Spec.	
	Operating Weight	Ground Pressure	Operating Weight	Ground Pressure
600 mm	43600 kg	81.2 kPa 0.83 kg/cm ²	44600 kg	77.3 kPa 0.79 kg/cm ²



DIMENSIONS

Model	PC450-8 / PC450LC-8	PC450-8 SE Spec. / PC450LC-8 SE Spec.
Boom Length	7060 mm	6670 mm
Arm Length	3380 mm	2400 mm
A Overall length	12040 mm	11635 mm
B Length on ground	6560 mm / 6725 mm	7860 mm
C Overall height (To top of boom)*	3660 mm	3665 mm
D Overall width	3430 mm	
E Overall height (To top of cab)*	3285 mm	
F Ground clearance, counterweight	1320 mm	
G Ground clearance (Minimum)	550 mm	
H Tail swing radius	3645 mm	
I Track length on ground	4020 mm / 4350 mm	4020 mm / 4350 mm
J Track length	5055 mm / 5385 mm	5055 mm / 5385 mm
K Track gauge	2740 mm	
L Width of crawler	3340 mm	
M Shoe width	600 mm	
N Grouser height	37 mm	
O Machine cab height	2920 mm	
P Machine cab width	3165 mm	
Q Distance, swing center to rear end	3605 mm	

* Including grouser height

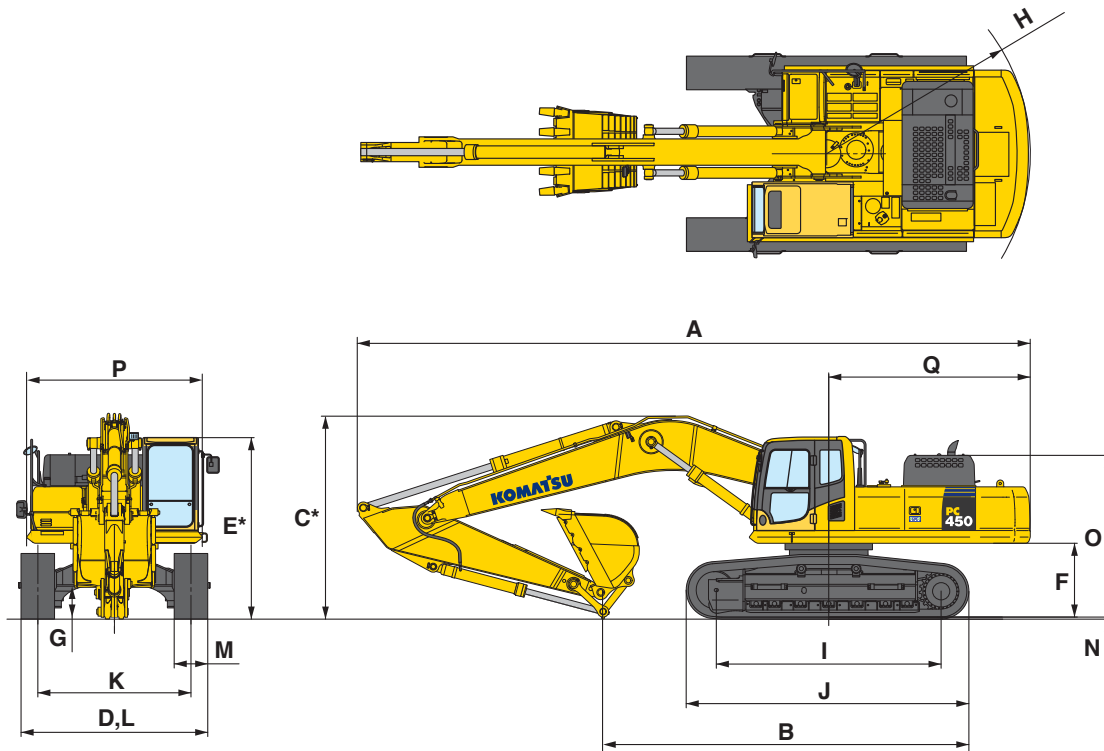



WORKING RANGE

Model		PC450-8 / PC450LC-8	PC450-8 SE Spec. / PC450LC-8 SE Spec.
Boom Length		7060 mm	6670 mm
Arm Length		3380 mm	2400 mm
A	Max. digging height	10925 mm	10155 mm
B	Max. dumping height	7625 mm	6605 mm
C	Max. digging depth	7790 mm	6740 mm
D	Max. vertical wall digging depth	6600 mm	3810 mm
E	Max. digging depth of cut for 2440 mm level	7650 mm	6570 mm
F	Max. digging reach	12005 mm	10975 mm
G	Max. digging reach at ground level	11800 mm	10750 mm
H	Min. swing radius	4805 mm	4470 mm
SAE 1179 Rating	Bucket digging force at power max.	243 kN 24800 kg	280 kN 28600 kg
	Arm crowd force at power max.	225 kN 22900 kg	260 kN 26600 kg
ISO 6015 Rating	Bucket digging force at power max.	278 kN 28300 kg	308 kN 31400 kg
	Arm crowd force at power max.	233 kN 23800 kg	269 kN 27400 kg

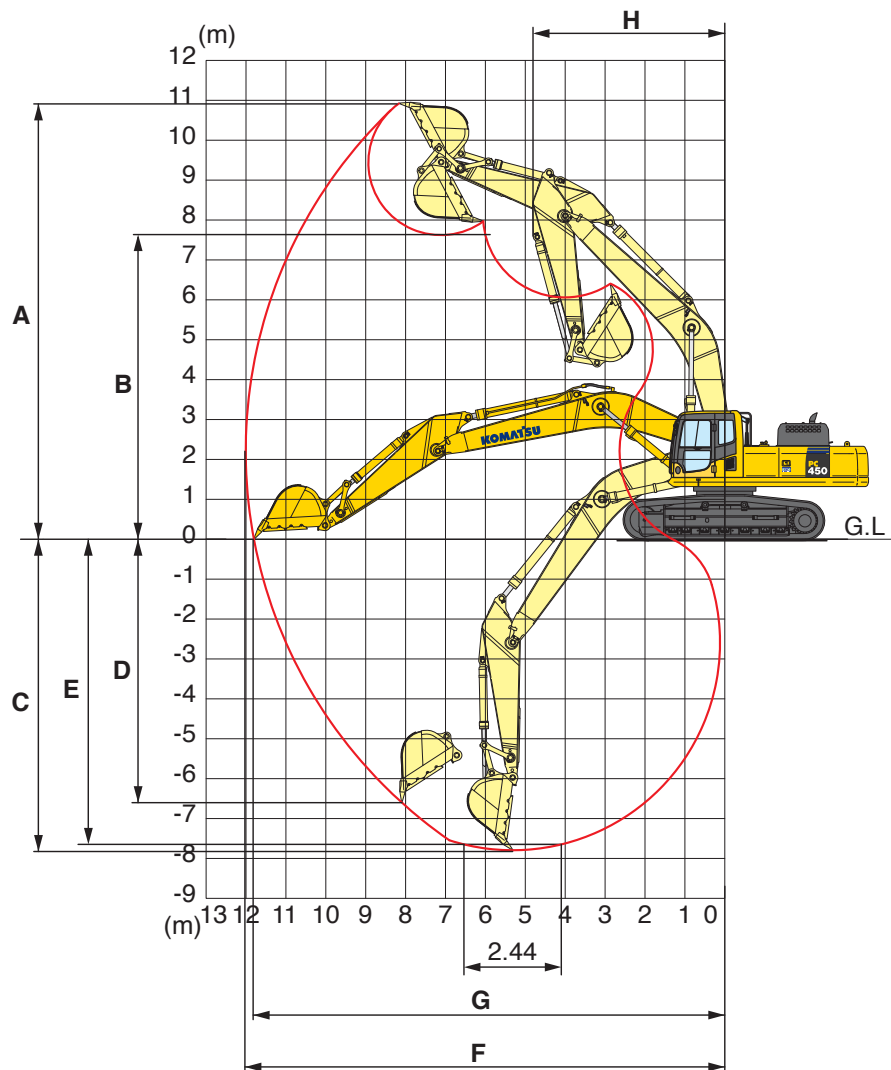



LIFTING CAPACITY WITH LIFTING MODE

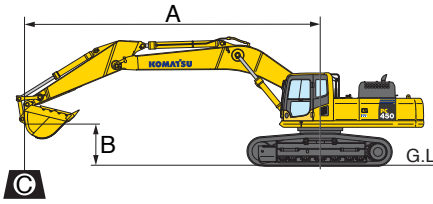

PC450-8 / PC450LC-8 / PC450-8 SE Spec. / PC450LC-8 SE Spec.

- A: Reach from swing center
- B: Bucket hook height
- C: Lifting capacity
- Cf: Rating over front
- Cs: Rating over side
- ☉: Rating at maximum reach

PC450-8 Boom: 7060 mm Arm: 3380 mm Bucket: 1.90 m ³ ISO 7451 heaped Shoe: 600 mm triple grouser													
B	A	☉ MAX		9.0 m		7.5 m		6.0 m		4.5 m		3.0 m	
		Cf	Cs	Cf	Cs	Cf	Cs	Cf	Cs	Cf	Cs	Cf	Cs
7.5 m		*6000 kg	5850 kg										
6.0 m		*6000 kg	4850 kg	8750 kg	5700 kg	*9600 kg	8200 kg						
4.5 m		*6200 kg	4250 kg	8550 kg	5500 kg	*10600 kg	7800 kg	*12800 kg	11500 kg				
3.0 m		6350 kg	3950 kg	8300 kg	5300 kg	11400 kg	7350 kg	*14950 kg	10650 kg	*20900 kg	16850 kg		
1.5 m		6200 kg	3800 kg	8000 kg	5050 kg	10900 kg	6900 kg	15850 kg	9950 kg	*17650 kg	15450 kg		
0 m		6350 kg	3850 kg	7800 kg	4850 kg	10550 kg	6600 kg	15300 kg	9450 kg	*17800 kg	14950 kg		
-1.5 m		6800 kg	4150 kg	7700 kg	4750 kg	10400 kg	6450 kg	15050 kg	9250 kg	*22950 kg	14950 kg		
-3.0 m		7750 kg	4800 kg	7750 kg	4750 kg	10400 kg	6450 kg	15100 kg	9300 kg	*20950 kg	15100 kg	*21700 kg	*21700 kg
-4.5 m		*9100 kg	6050 kg			*10350 kg	6600 kg	*13750 kg	9500 kg	*17700 kg	15450 kg	*22350 kg	*22350 kg
-6.0 m		*8050 kg	*8050 kg					*9450 kg	*9450 kg	*12600 kg	*12600 kg		

PC450LC-8 Boom: 7060 mm Arm: 3380 mm Bucket: 1.90 m ³ ISO 7451 heaped Shoe: 600 mm triple grouser													
B	A	☉ MAX		9.0 m		7.5 m		6.0 m		4.5 m		3.0 m	
		Cf	Cs	Cf	Cs	Cf	Cs	Cf	Cs	Cf	Cs	Cf	Cs
7.5 m		*6000 kg	5950 kg										
6.0 m		*6000 kg	4950 kg	*8850 kg	5800 kg	*9600 kg	8350 kg						
4.5 m		*6200 kg	4350 kg	*9250 kg	5650 kg	*10600 kg	7950 kg	*12800 kg	11700 kg				
3.0 m		*6550 kg	4000 kg	9400 kg	5400 kg	*11750 kg	7500 kg	*14950 kg	10850 kg	*20900 kg	17150 kg		
1.5 m		7150 kg	3900 kg	9150 kg	5150 kg	12450 kg	7050 kg	*16650 kg	10100 kg	*17650 kg	15750 kg		
0 m		7300 kg	3950 kg	8950 kg	4950 kg	12100 kg	6750 kg	*17300 kg	9650 kg	*17800 kg	15200 kg		
-1.5 m		7800 kg	4250 kg	8850 kg	4850 kg	11900 kg	6600 kg	*17100 kg	9450 kg	*22950 kg	15200 kg		
-3.0 m		8900 kg	4900 kg	8850 kg	4900 kg	11900 kg	6550 kg	*16000 kg	9450 kg	*20950 kg	15400 kg	*21700 kg	*21700 kg
-4.5 m		*9100 kg	6200 kg			*10350 kg	6750 kg	*13750 kg	9650 kg	*17700 kg	15750 kg	*22350 kg	*22350 kg
-6.0 m		*8050 kg	*8050 kg					*9450 kg	*9450 kg	*12600 kg	*12600 kg		

PC450-8 SE Spec. Boom: 6670 mm Arm: 2400 mm Me bucket: 2.80 m ³ ISO 7451 heaped Shoe: 600 mm triple grouser													
B	A	☉ MAX		9.0 m		7.5 m		6.0 m		4.5 m		3.0 m	
		Cf	Cs	Cf	Cs	Cf	Cs	Cf	Cs	Cf	Cs	Cf	Cs
7.5 m		*10850 kg	8300 kg										
6.0 m		10050 kg	6500 kg			*11050 kg	7900 kg	*12700 kg	11900 kg				
4.5 m		8750 kg	5550 kg			11700 kg	7550 kg	*14400 kg	11150 kg	*19050 kg	18100 kg		
3.0 m		8100 kg	5050 kg	8200 kg	5100 kg	11200 kg	7100 kg	*16150 kg	10350 kg				
1.5 m		7900 kg	4900 kg	8000 kg	4950 kg	10900 kg	6800 kg	15700 kg	9700 kg				
0 m		8200 kg	5050 kg	7900 kg	4850 kg	10650 kg	6550 kg	15300 kg	9350 kg	*22450 kg	14350 kg		
-1.5 m		9000 kg	5550 kg			10550 kg	6500 kg	15250 kg	9300 kg	*20500 kg	15000 kg	*20000 kg	*20000 kg
-6.0 m													

PC450LC-8 SE Spec. Boom: 6670 mm Arm: 2400 mm Me bucket: 2.80 m ³ ISO 7451 heaped Shoe: 600 mm triple grouser													
B	A	☉ MAX		9.0 m		7.5 m		6.0 m		4.5 m		3.0 m	
		Cf	Cs	Cf	Cs	Cf	Cs	Cf	Cs	Cf	Cs	Cf	Cs
7.5 m		*10500 kg	8100 kg										
6.0 m		*10100 kg	6250 kg			*10500 kg	7650 kg	*12200 kg	11750 kg				
4.5 m		9650 kg	5300 kg	9200 kg	5000 kg	*11200 kg	7300 kg	*13950 kg	11050 kg	*18650 kg	18200 kg		
3.0 m		8950 kg	4800 kg	9000 kg	4800 kg	*12050 kg	6850 kg	*15650 kg	10250 kg				
1.5 m		8750 kg	4650 kg	8800 kg	4600 kg	12150 kg	6600 kg	*16500 kg	9600 kg				
0 m		9050 kg	4800 kg	8700 kg	4500 kg	11900 kg	6350 kg	*16550 kg	9250 kg	*21750 kg	14100 kg		
-1.5 m		*10000 kg	5300 kg			*11850 kg	6300 kg	*15600 kg	9150 kg	*20050 kg	15100 kg	*19650 kg	*19650 kg
-6.0 m													

* Load is limited by hydraulic capacity rather than tipping. Ratings are based on SAE J1097. Rated loads do not exceed 87% of hydraulic lift capacity or 75% of tipping load.



STANDARD EQUIPMENT

ENGINE:

- Automatic engine warm-up system
- Corrosion resistor
- Dry type air cleaner, double element
- Engine, Komatsu SAA6D125E-5
- Engine overheat prevention system
- Fuel pre-filter (With water separator)
- Radiator and oil cooler dust proof net
- Water separator

ELECTRICAL SYSTEM:

- Alternator, 24 V/50 A
- Auto-decelerator
- Batteries, 2 X 12 V/110 Ah
- Working light, 2 (Boom and RH)

HYDRAULIC SYSTEM:

- Boom holding valve
- Long lubricating intervals for implement bushings
- Power maximizing system
- Pressure Proportional Control (PPC) hydraulic control system
- Two-mode setting for boom
- Working mode selection system

GUARDS AND COVERS:

- Fan guard structure
- Track roller guards (Full length)

UNDERCARRIAGE:

- Hydraulic track adjusters (Each side)
- Track roller
 - PC450-8, 7 each side
 - PC450LC-8, 8 each side

- Track shoe
 - PC450-8, 600 mm triple grouser
 - PC450LC-8, 600 mm triple grouser

OPERATOR ENVIRONMENT:

- Large multi-lingual LCD monitor
- Rear view mirrors (RH and LH)
- ROPS cab (ISO 12117-2)
- Seat belt, retractable

OTHER EQUIPMENT:

- Counterweight, 9220 kg
- Electric horn
- Rear reflector
- Slip-resistant plates
- Travel alarm



OPTIONAL EQUIPMENT

ELECTRICAL SYSTEM:

- Alternator, 24 V/60 A
- Batteries, 2 X 12 V/140 Ah
- Working lights (2 on cab)

HYDRAULIC SYSTEM:

- Attachment piping
- Long lubricating intervals for work equipment bushings
- Service valve

UNDERCARRIAGE:

- Shoes, triple grouser shoes
 - PC450-8, 700 mm
 - PC450LC-8, 700 mm
- Track frame undercover
- Variable track gauge

OPERATOR ENVIRONMENT:

- A/C with defroster
- Bolt-on top guard, OPG top guard level 2 (ISO 10262)
- Cab accessories
 - Rain visor
 - Sun visor
- Cab front guard
 - Full height guard, OPG level 1 (ISO 10262)
 - Full height guard, OPG level 2 (ISO 10262)
 - Half height guard
- Heater with defroster
- Rear view mirror (Rear and sidewise)
- Rear view monitor system
- Seat, suspension
- Seat, suspension with heater

WORK EQUIPMENT:

- Arms
 - 3380 mm arm assembly
 - 2400 mm SE arm assembly
- Booms (Backhoe)
 - 7060 mm boom assembly
 - 6670 mm SE boom assembly

OTHER EQUIPMENT:

- Electric grease gun
- Fuel refill pump
- Pre-cleaner